

B - 1698mm  
H - 741mm  
T - 450mm

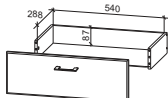

|         |      |     |   |     |
|---------|------|-----|---|-----|
| 1L+1R   | 606  | 448 | 2 | 1/2 |
| 3       | 1696 | 450 | 1 | 2/2 |
| 4       | 1696 | 450 | 1 | 2/2 |
| 5       | 1600 | 74  | 1 | 2/2 |
| 6       | 405  | 74  | 4 | 2/2 |
| 7       | 606  | 348 | 1 | 1/2 |
| 8       | 606  | 348 | 1 | 1/2 |
| 9       | 606  | 348 | 1 | 1/2 |
| 10      | 580  | 347 | 2 | 1/2 |
| 11      | 418  | 330 | 2 | 1/2 |
| 12      | 200  | 335 | 1 | 1/2 |
| 13L+13R | 600  | 410 | 2 | 1/2 |
| 14      | 592  | 203 | 1 | 1/2 |
| 15      | 595  | 203 | 1 | 1/2 |
| 16      | 573  | 220 | 1 | 1/2 |
| 17      | 540  | 100 | 2 | 1/2 |
| 17L+17R | 302  | 100 | 4 | 1/2 |
| 18      | 551  | 300 | 2 | 1/2 |
| 19      | 1024 | 615 | 1 | 2/2 |
| 20      | 648  | 615 | 1 | 2/2 |

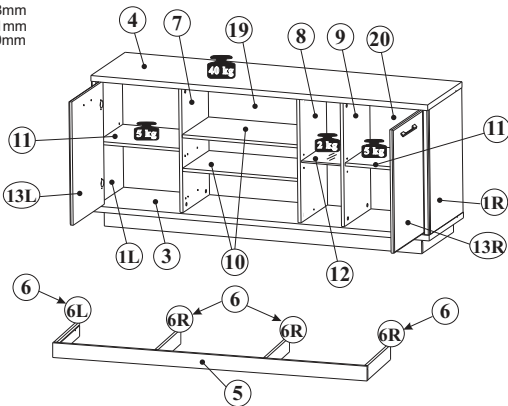

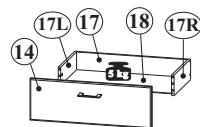
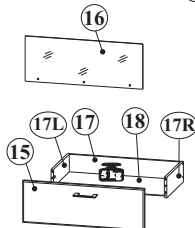
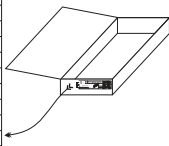
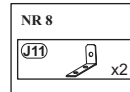
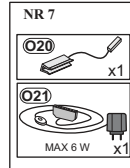
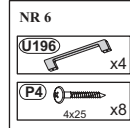
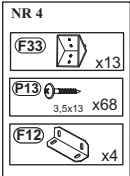
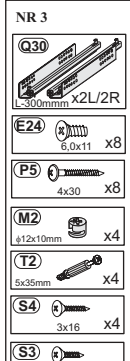
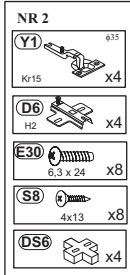
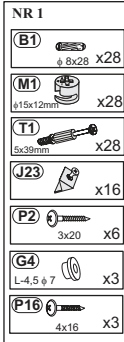





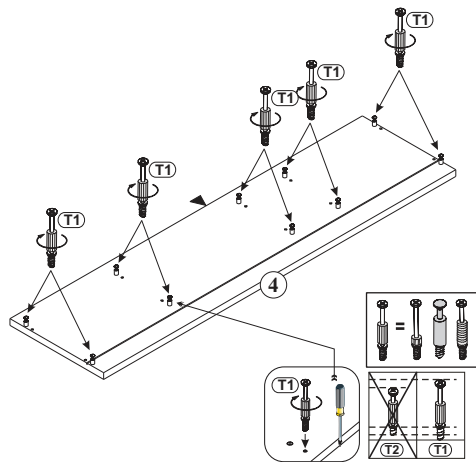
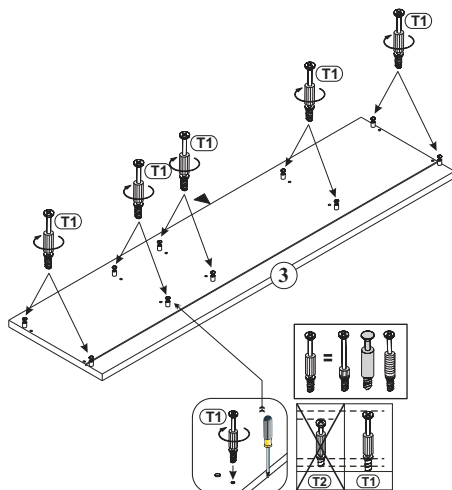

C 1/2



|   |   |   |
|---|---|---|
| <b>PL</b> - Produkt nie zawiera części szklanych, które są wrażliwe na uderzenia mechaniczne nie podlegające rozporządzeniu (UE) 2019/2015                            | <b>DE</b> Diese Produkte enthalten Lichtquellen, die aufgrund ihrer Eigenschaften nicht unter die Verordnung (EU) 2019/2015 fallen                            | <b>CS</b> Tyto výrobky obsahují světelné zdroje, které vzhledem ke svým vlastnostem nepodléhají do oblasti působnosti nařízení (EU) 2019/2015         |
| <b>DA</b> - Disse produkter indeholder lyskilder, som på grund af deres egenskaber er uden for anvendelsesområdet for forordningen (EU) 2019/2015                     | <b>EL</b> - Αυτά τα προϊόντα περιλαμβάνουν πηγές φωτός οι οποίες, λόγω των ιδιοτήτων τους, δεν καλύπτονται από τη νέα ρύθμιση/το νέο κανονισμό (UE) 2019/2015 | <b>EW</b> - These products contain light sources which, due to their properties, are out of the scope of Regulation (EU) 2019/2015                    |
| <b>ES</b> - Estos productos contienen fuentes de luz que, por sus propiedades, quedan fuera del ámbito de aplicación del Reglamento (UE) 2019/2015.                   | <b>ET</b> - Need tootet sisalduvad valgusallikad, mis on oma omaduste tõttu väljaspool määruse (EÜ) 2019/2015 reguleerimisalast vältis                        | <b>FI</b> - Nämä tuotteet sisältävät valonläitä, jotka kuuluvat määränne voimaan tulon jälkeen sovellettiin   |
| <b>FR</b> - Ces produits contiennent des sources lumineuses qui, en raison de leurs propriétés, n'entrent pas dans le champ d'application du règlement (UE) 2019/2015 | <b>HU</b> - Ezek a termékek olyan fényforrások tartalmazzak, amelyek tulajdonságai miatt nem tartoznak az (EU) 2019/2015 rendelet hatálya alá                 | <b>IT</b> - Questi prodotti contengono sorgenti luminose che, per le loro proprietà, esulano dal campo di applicazione del Regolamento (UE) 2019/2015 |
| <b>LT</b> - Šiuose gaminių yra šviesos šaltiniai, kurie dėl savo savybių nepatenka į Reglamentą (EU) 2019/2015 taikymo sritį  | <b>LV</b> - Šie produkti satur gaismas avotus, kas to īpašību dēļ ir ārpus Regulas (Ei) 2019/2015 darbības jomas  | <b>RU</b> - Эти продукты содержат источники света, которые не в scope действия не подпадают под действие Регламента (ЕС) 2019/2015.                   |
| <b>PT</b> - Estes produtos contêm fontes de luz que, devido às suas propriedades, estão fora do âmbito do Regulamento (UE) 2019/2015                                  | <b>RO</b> - Aceste produse conțin surse de lumină care, datorită proprietăților lor, nu sînt în domeniul de aplicare al Regulamentului (UE) 2019/2015         | <b>NL</b> - Deze producten bevatten lichtbronnen die vanwege hun eigenschappen buiten het toepassingsgebied van Verordening (EU) 2019/2015 vallen     |
| <b>SK</b> - Tieto výrobky obsahujú svetelné zdroje, ktoré vzhľadom na svoje vlastnosti nepatria do rozsahu pôsobnosti nariadenia (EÚ) 2019/2015                       | <b>SL</b> - Ti izdelki vsebujejo svetlobne vire, ki zaradi svojih lastnosti ne spadajo na področje uporabe Uredbe (EU) 2019/2015                              | <b>SV</b> - Dessa produkter innehåller ljuskällor som på grund av sina egenskaper inte omfattas av förordningen (EU) 2019/2015                        |
| <b>TR</b> - Bu ürünler, özellikleri nedeniyle buji ışık kaynakları kapsamına dâhil değildir.  | <b>HR</b> - Ovi proizvodi sadrže izvorne svjetlosti koji zbog svojih osobina nisu obuhvaćeni Uredbom (EU) 2019/2015   | <b>BG</b> - Тези продукти съдържат източници на светлина, които поради своите свойства не са обхванати на Регламента (ЕС) 2019/2015                   |



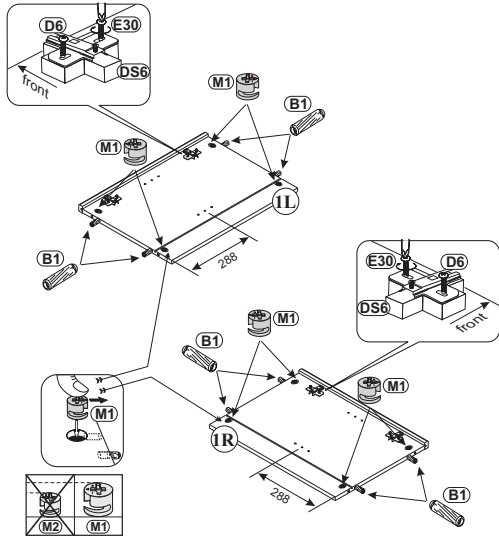

3

- B1**   $\phi$  8x28 x8
- DS6**  x4
- E30**  6.3 x 24 x8
- M1**   $\phi$  15x12mm x8
- D6**  H2 x4



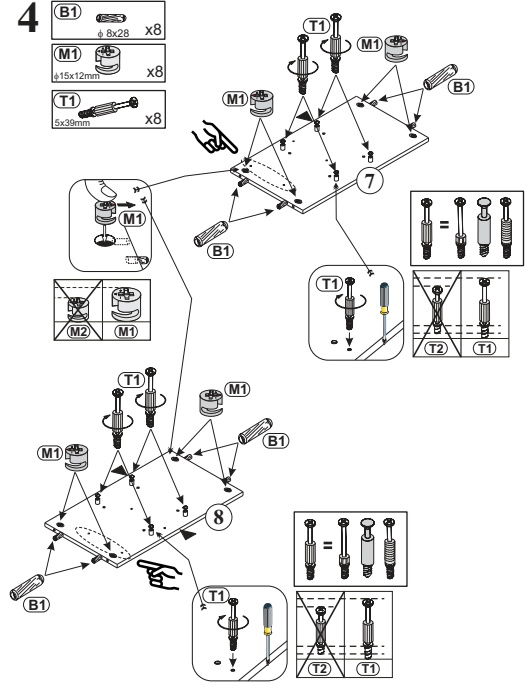

4

- B1**   $\phi$  8x28 x8
- M1**   $\phi$  15x12mm x8
- T1**  5x39mm x8





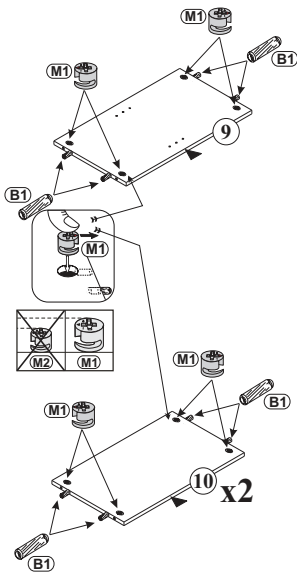

5

- B1**   $\phi$  8x28 x12
- M1**   $\phi$  15x12mm x12



6

- F33**  x13
- F12**  x4
- F15**  x12
- P13**  3.5x13 x34

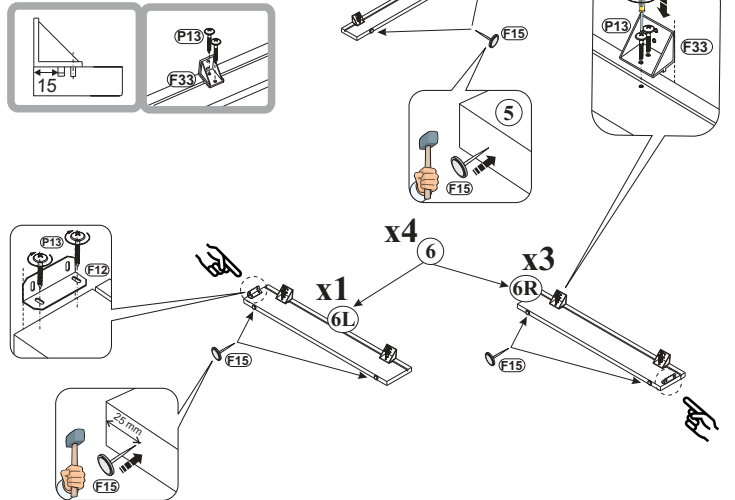

7

P13 3.5x13 x8

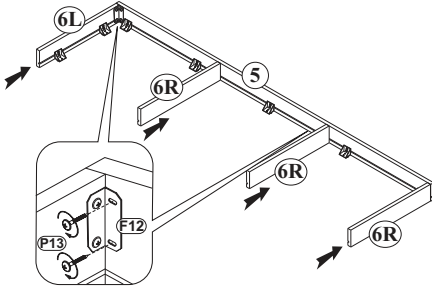

8

P13 3.5x13 x26

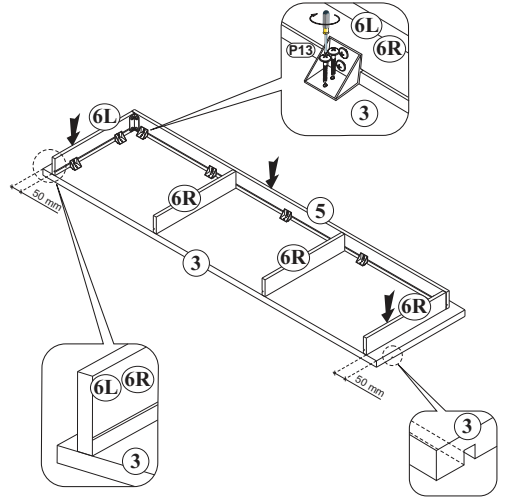

9

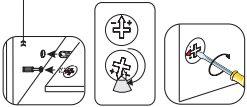
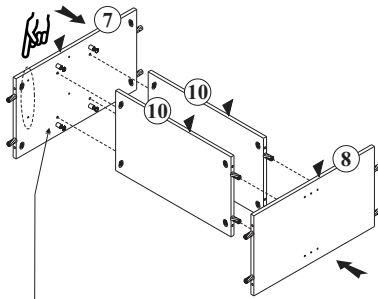

10

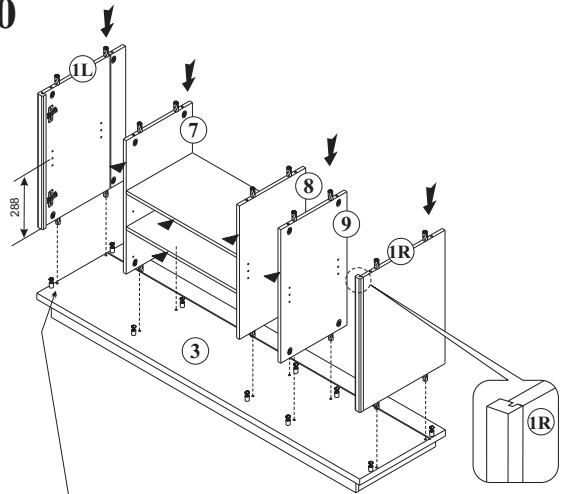

11

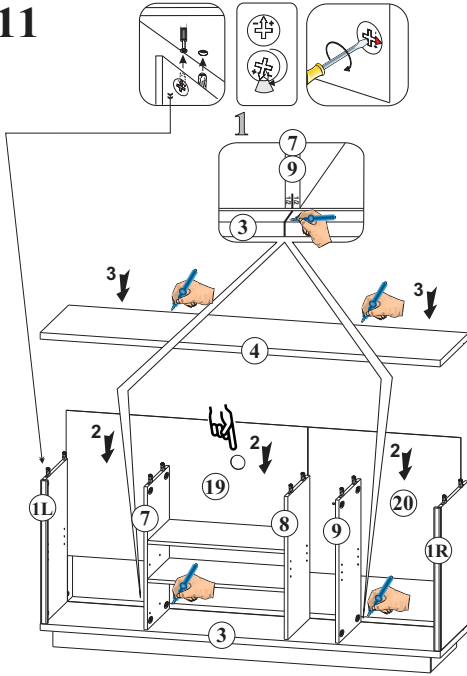

12

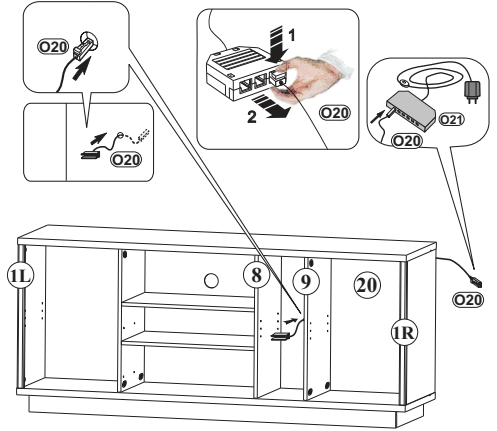
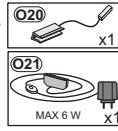

13

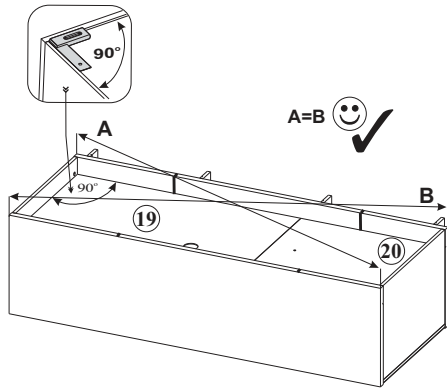

14

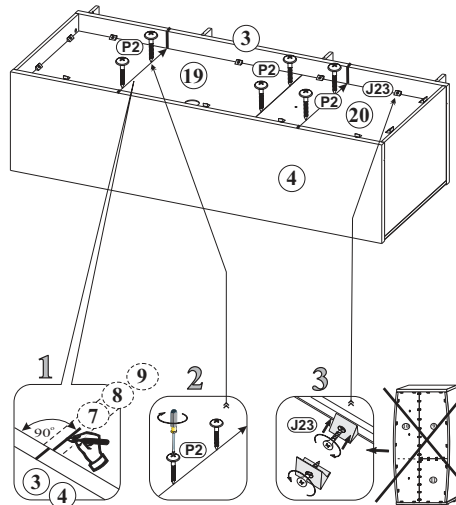
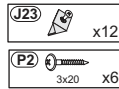

15

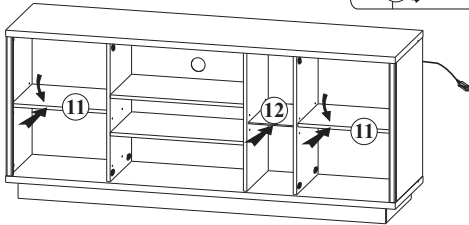
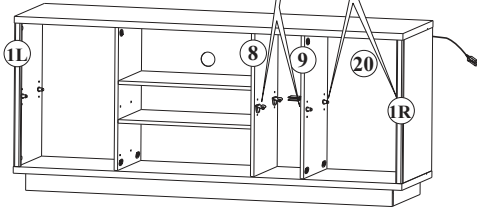
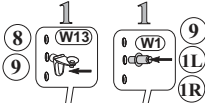
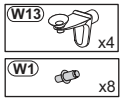

16

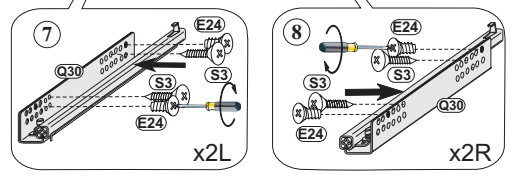
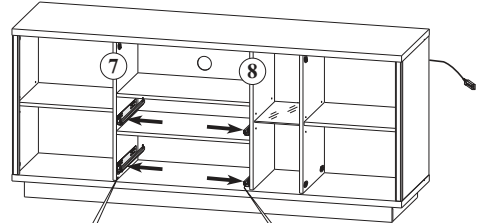
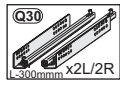

17

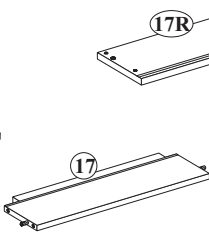
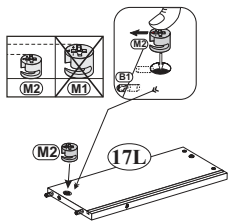
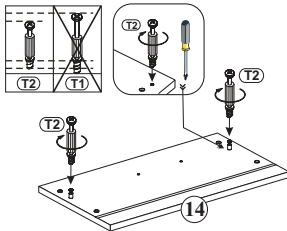
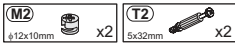

18

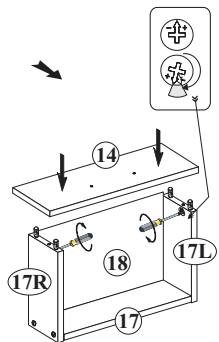
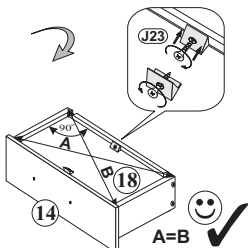
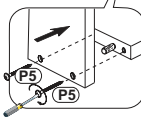
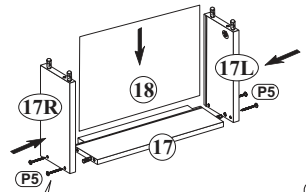
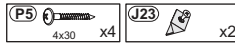

19

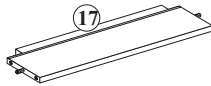
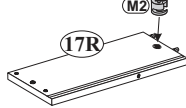
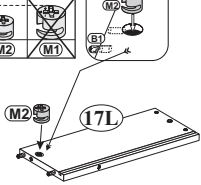
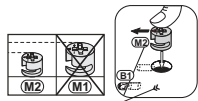
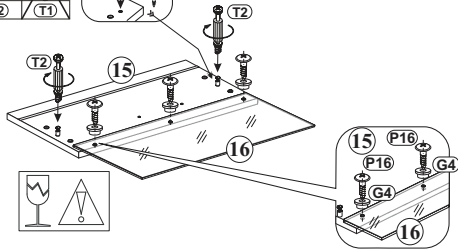
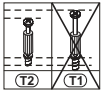

20

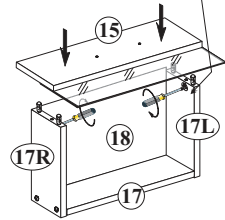
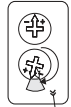
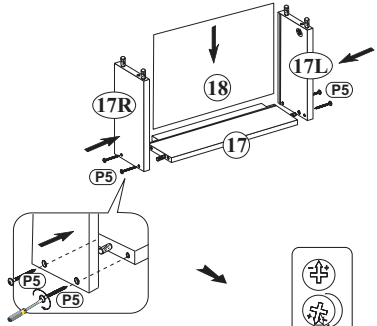
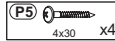

21

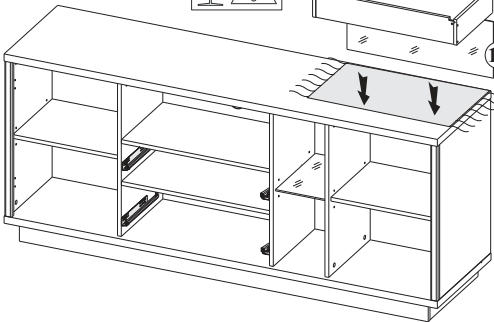
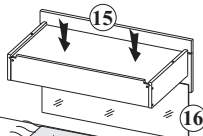

22

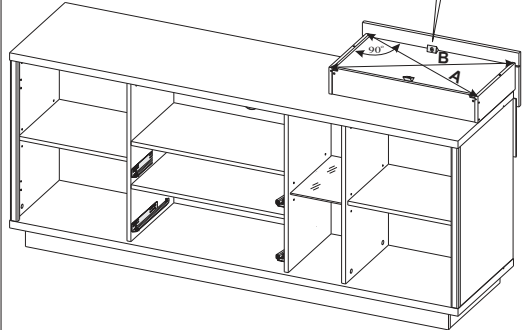

23

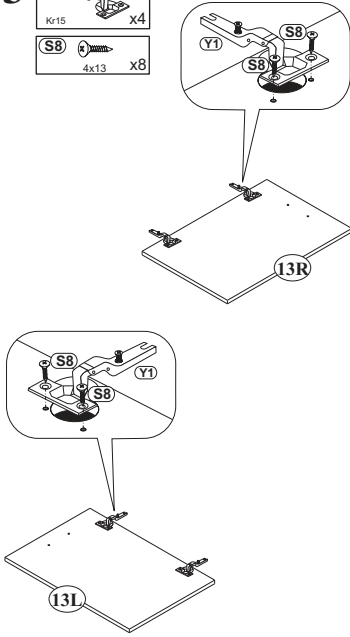
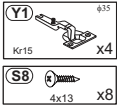

24

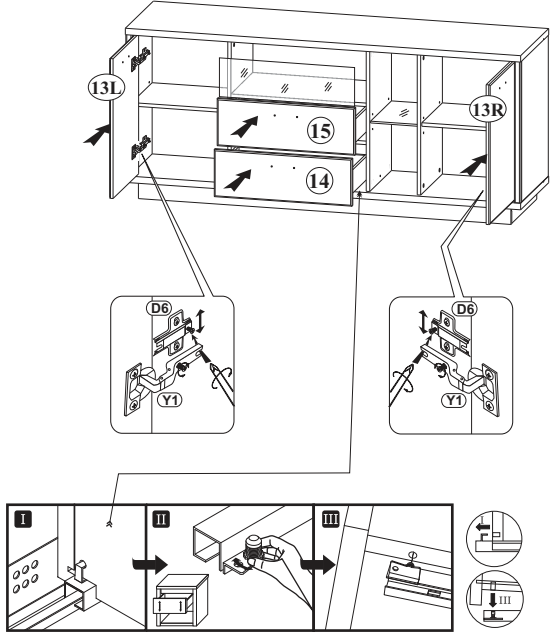

25

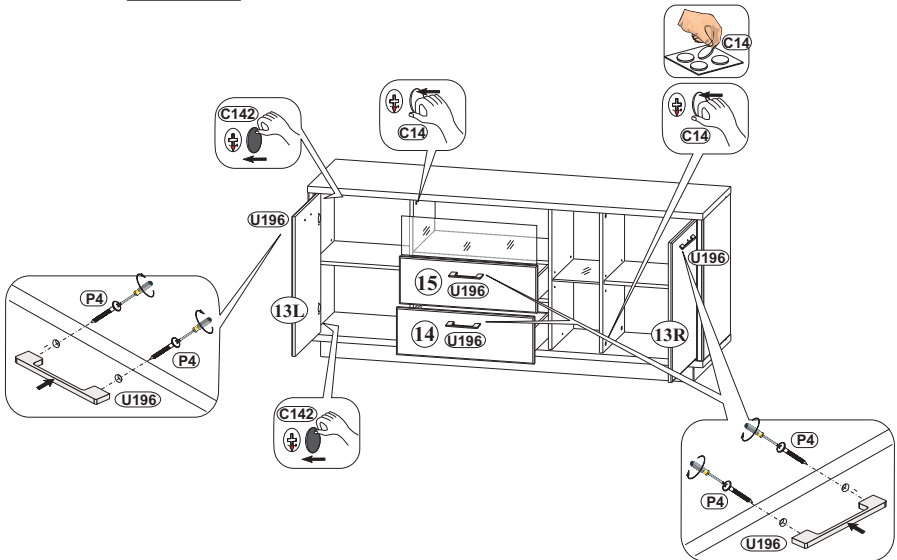



26

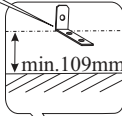
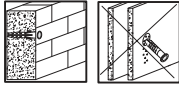
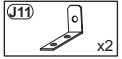
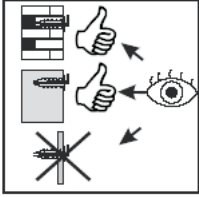

1200mm

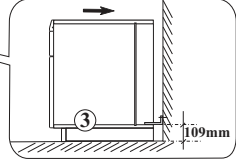
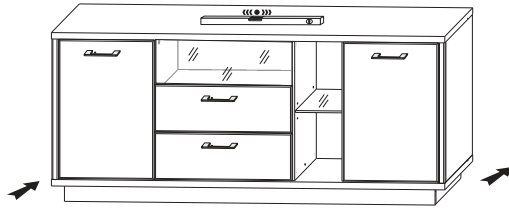

27

