

B - 1500mm  
H - 420mm  
T - 250mm

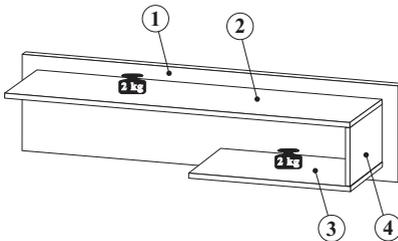

<b>NR 1</b>	<b>(F50)</b>		x3
<b>E2</b>		6x8	x6
<b>C14</b>		420mm	x1
<b>C142</b>		420mm	x2
<b>B1</b>		4 8x28	x2
<b>M1</b>			x2
<b>T1</b>		5x39mm	x2
<b>K2</b>		7x70	x15

<b>NR 2</b>	<b>(T10)</b>		x3
<b>(S25)</b>		4x70	x1
<b>C18</b>		5mm	x3



1	1500	420	1	1/1
2	1424	235	1	1/1
3	624	235	1	1/1
4	288	233	1	1/1

1

- B1**  x2
- M1**  x2
- T1**  5x39mm x2

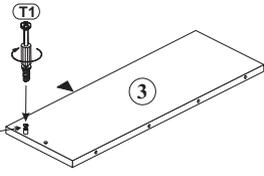
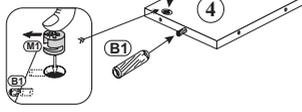
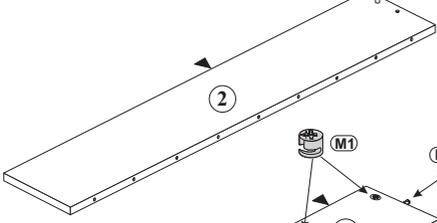
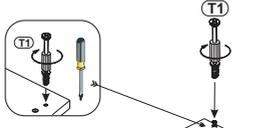

2

- F50**  x3
- E2**  6x8 x6
- C18**  5mm x3

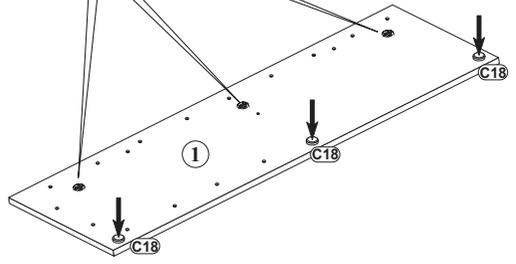
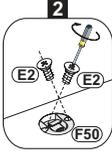
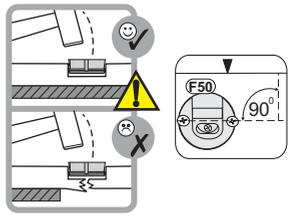

3

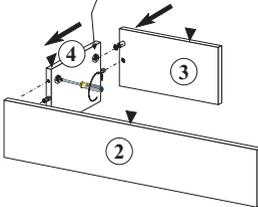
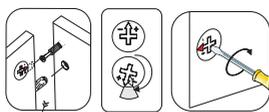

4

- K2**  7x70 x15

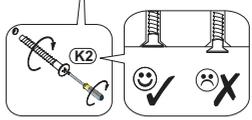
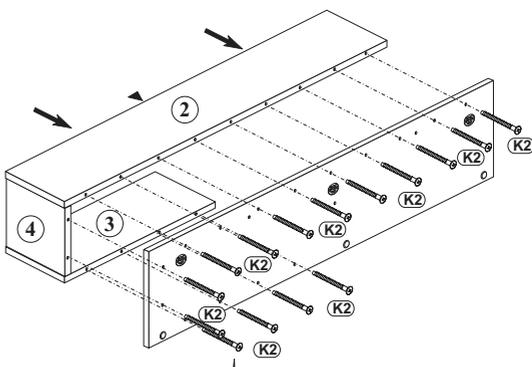

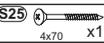
- 5** **T10**  x3
- S25**  4x70 x1
- C14**   $\varnothing 20$ mm x1

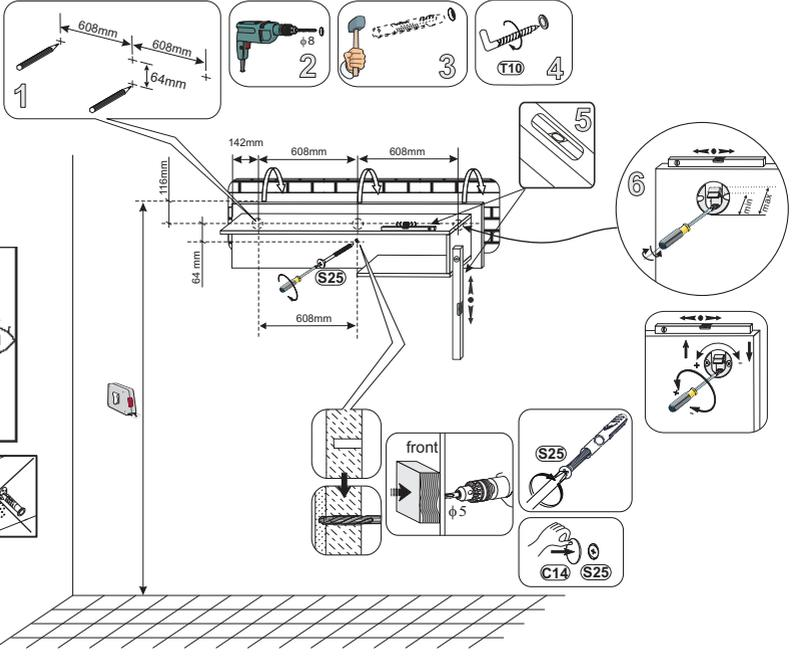

- 6** **C142**   $\varnothing 20$ mm x2

