

COUNTRY

8X--CT 16

1 / 6

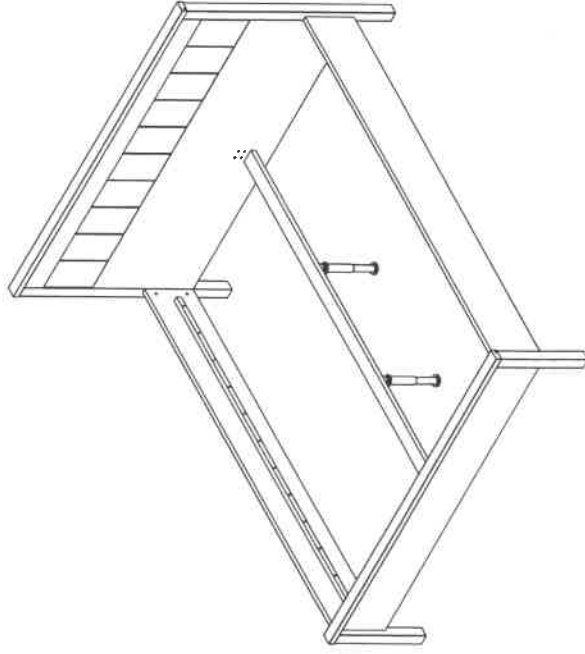
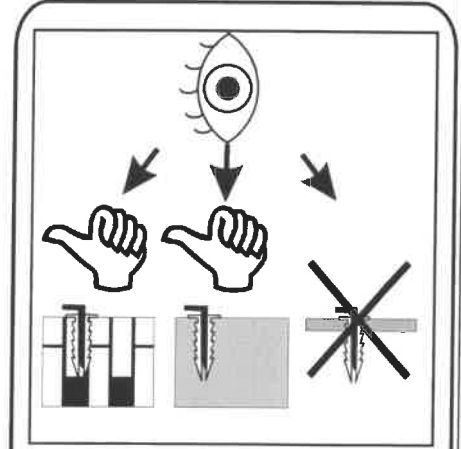
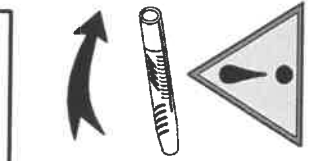
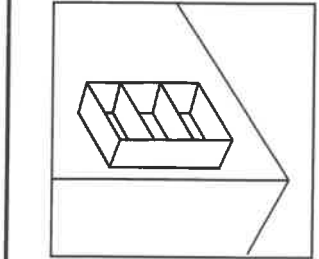
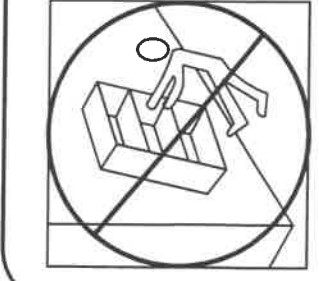
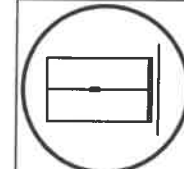
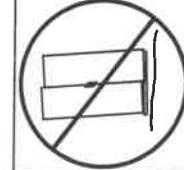
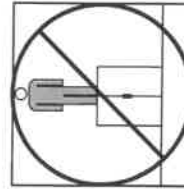
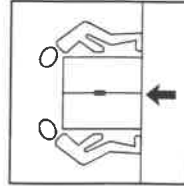
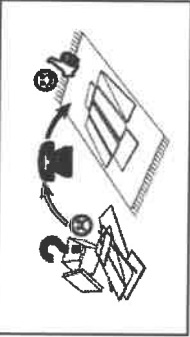
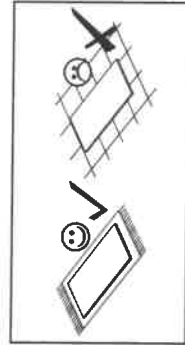
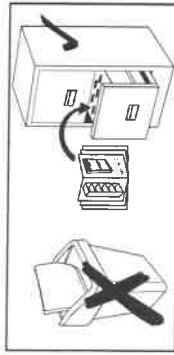
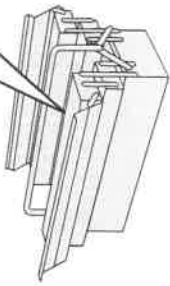
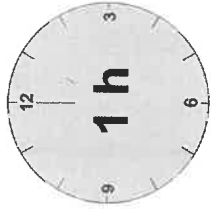
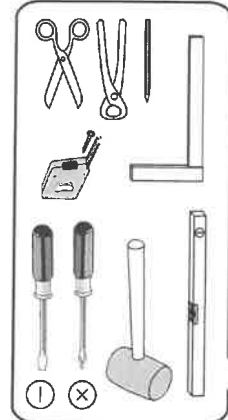
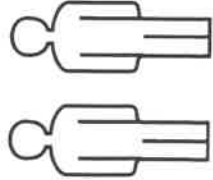
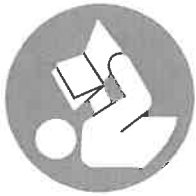

B - 1707mm
H - 2109mm
T - 1100mm

B - 1707mm
 H - 1100mm
 T - 2109mm

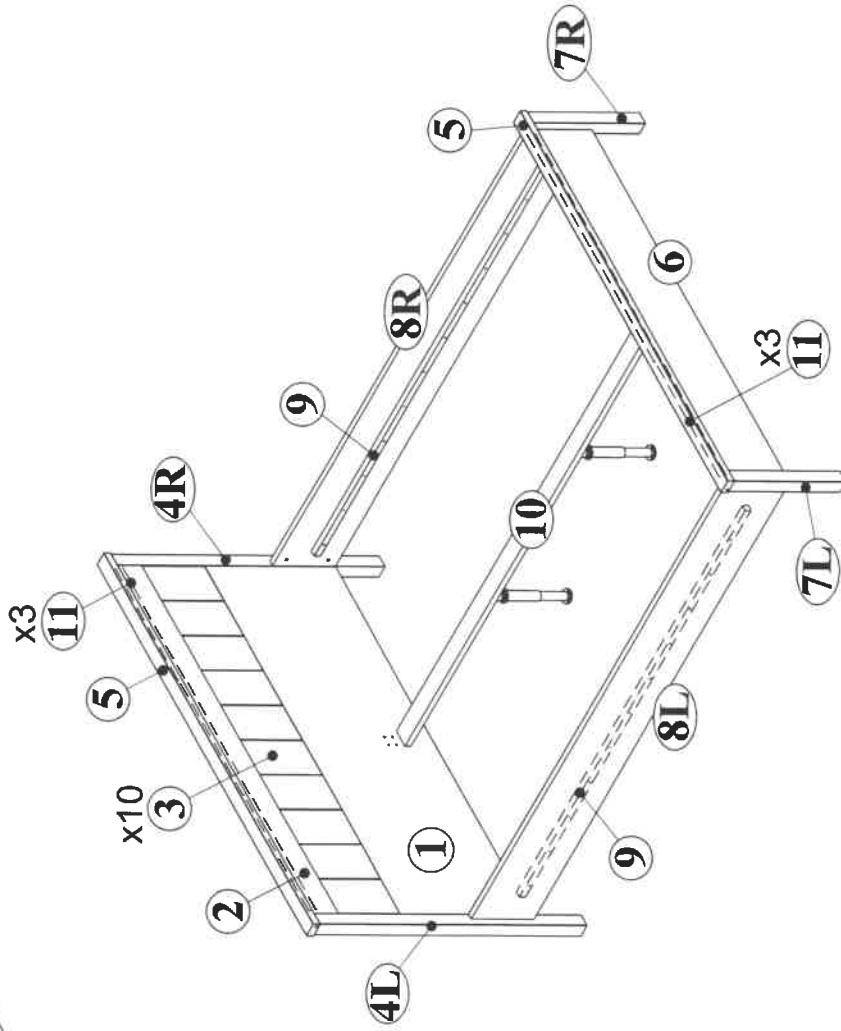
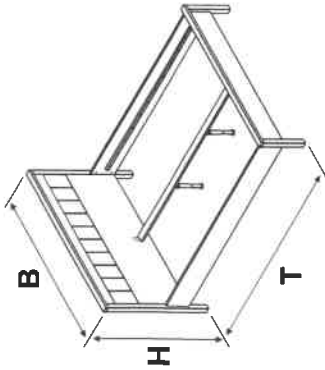

NR 1

- J2** L-160 x2
- E5** 6,3x13 x6
- S5** 4x20 mm x8
- B4** φ 10x50 x8
- G6** Ø10x16 x4
- G17** M6x90 x4
- G7** x1
- F15** x4

NR 2

- B3** φ 6x45 x40
- B2** φ 8x50 x16
- M1** x8
- T1** x8
- L1** GULE LEM x4

NR 3

- F19** x2
- F20** x2
- E2** Ø 6,0x11 x8
- S3** Ø 4x16 x4

NR 4

- N4** x2
- N5** x2
- P3** 3,5x18 x4

S16 4x50 x24

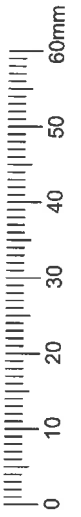

1

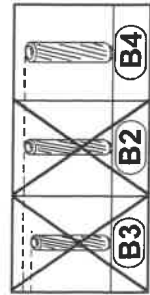
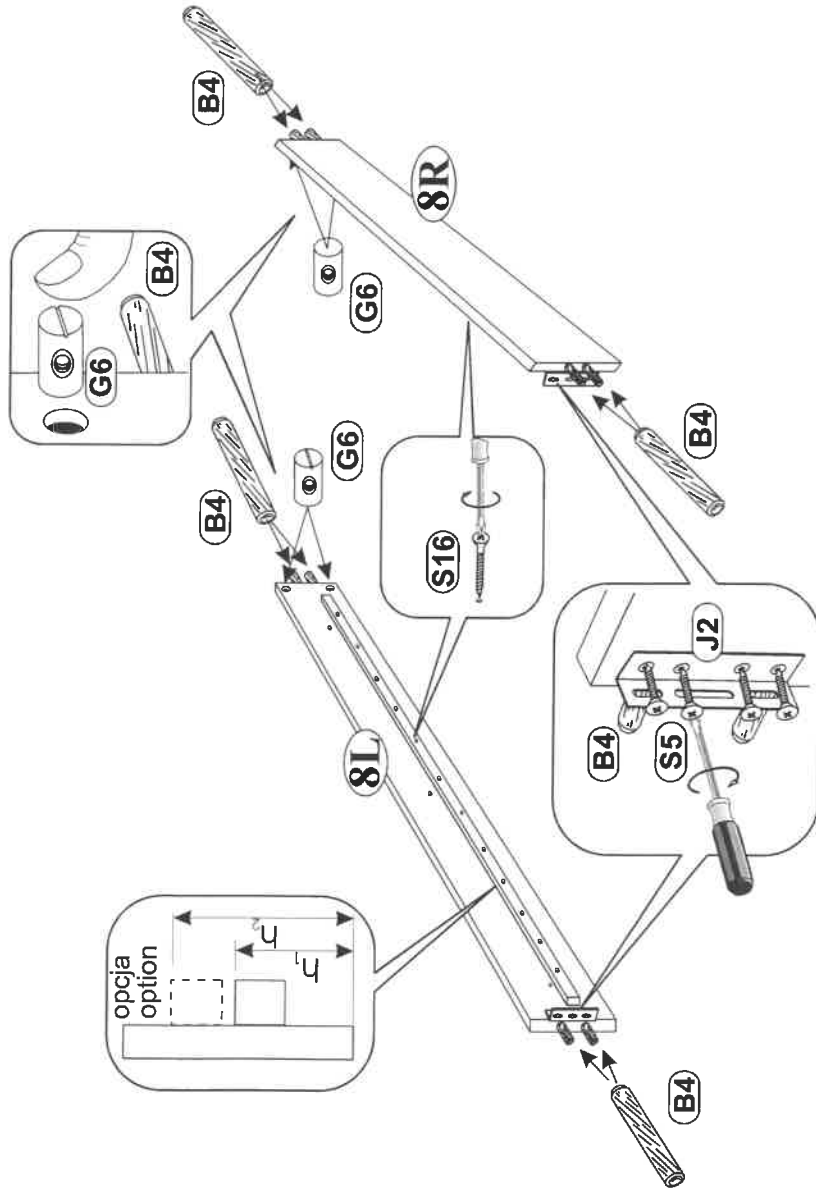
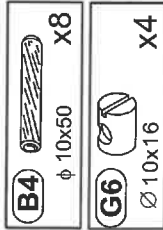

2

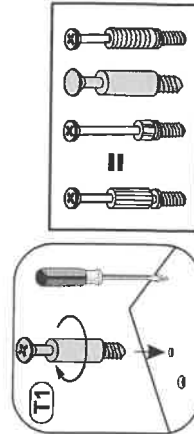
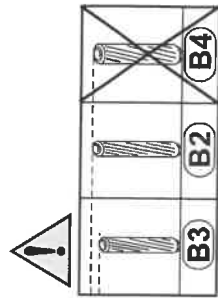
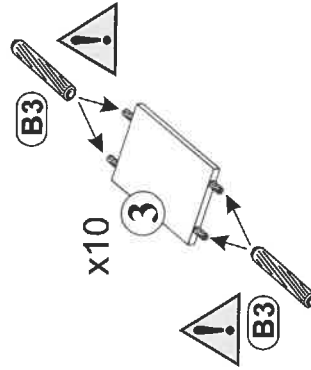
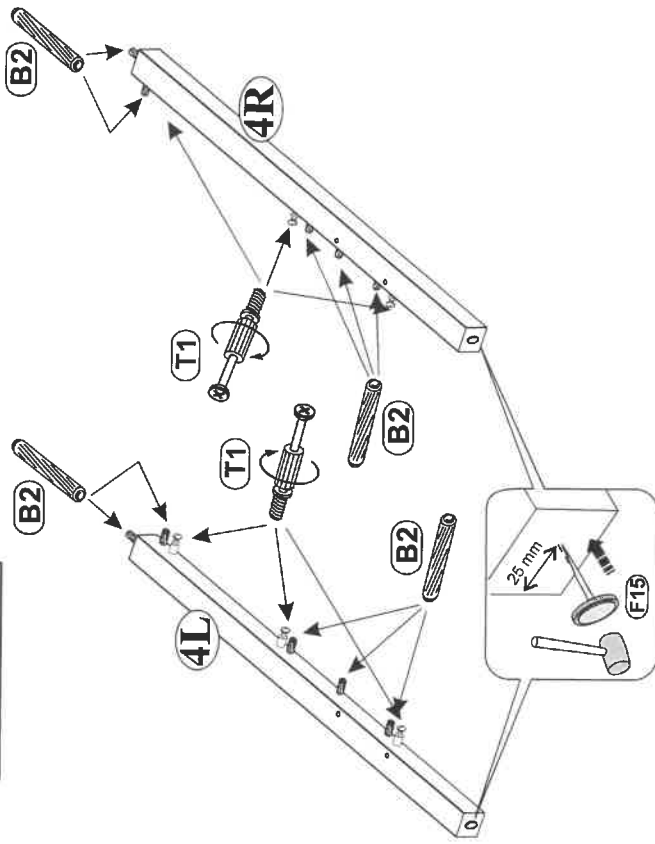
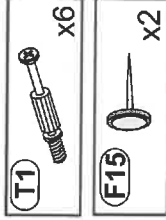

3

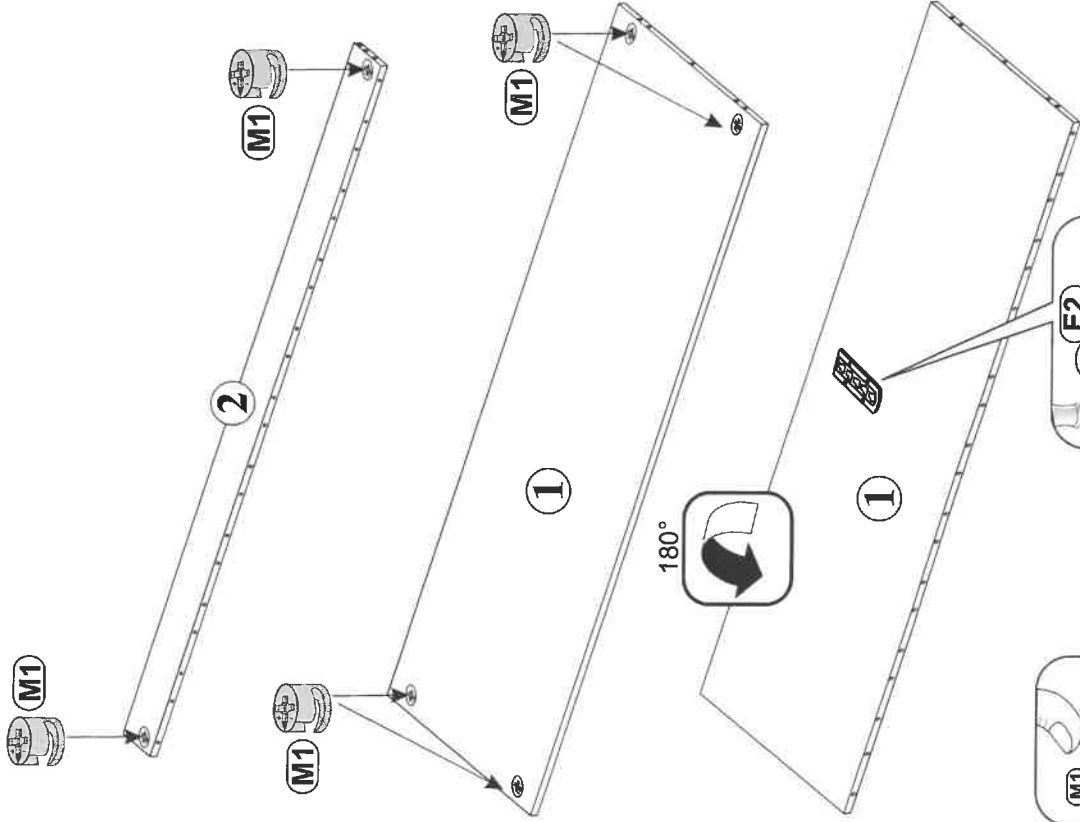
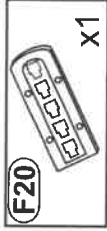



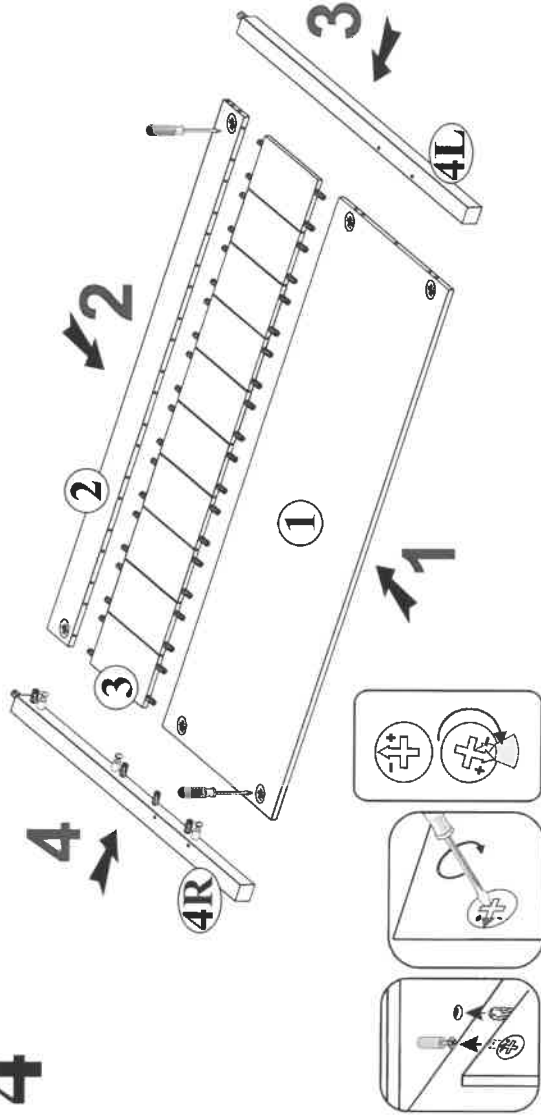



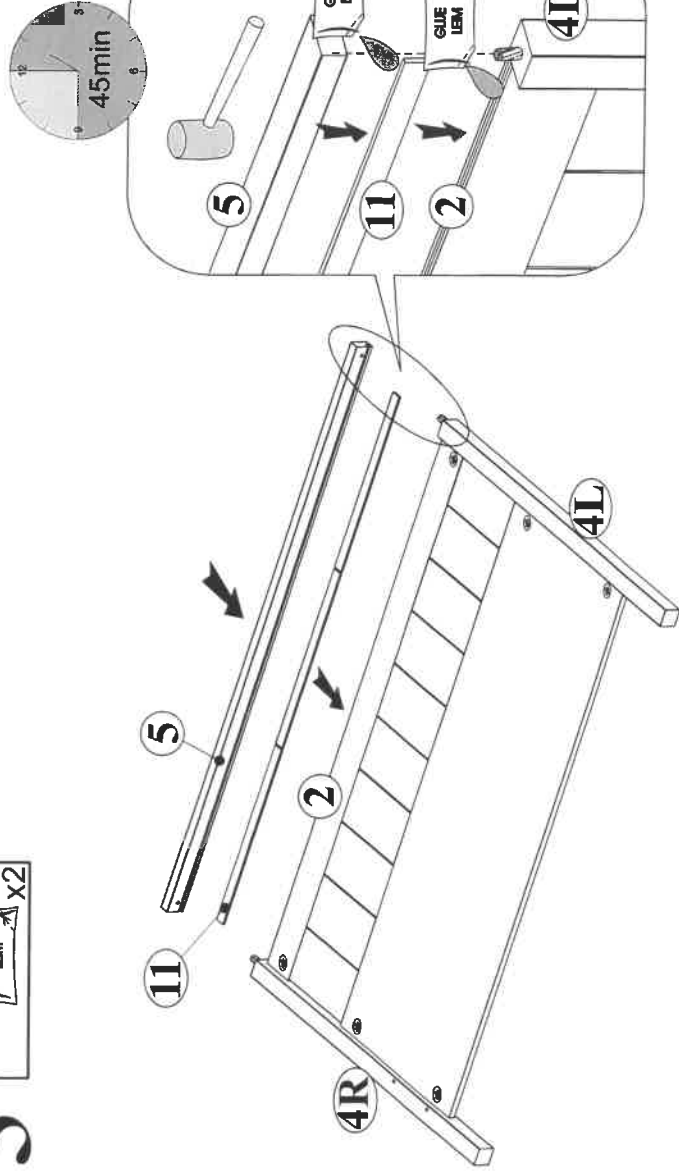

4



5



6

- | | | | |
|---|---|---|---|
|  |  |  |  |
| x2 | x2 | x1 | x2 |
|  |  |  |  |
| x2 | x4 | ∅ 6,0x11 | x6 |
| | | | φ 8x50 |

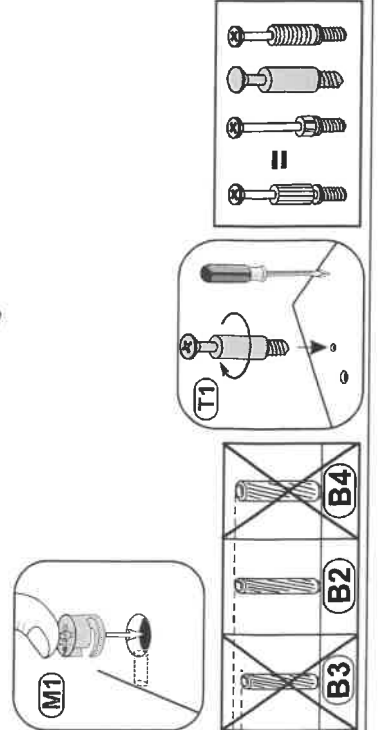
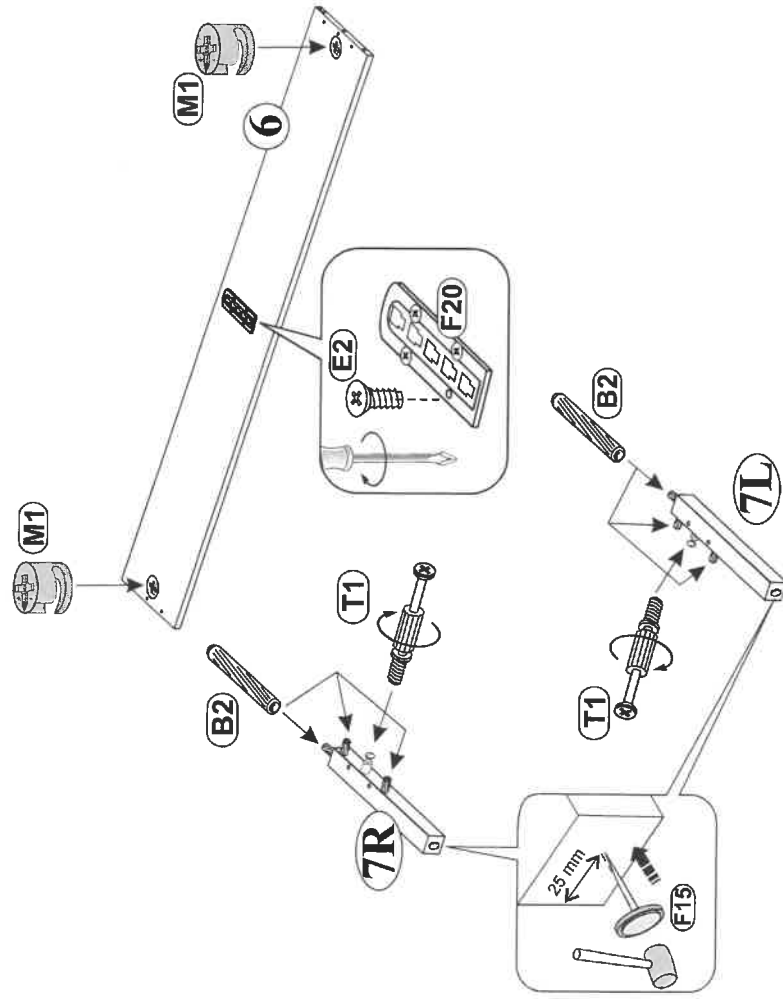

7

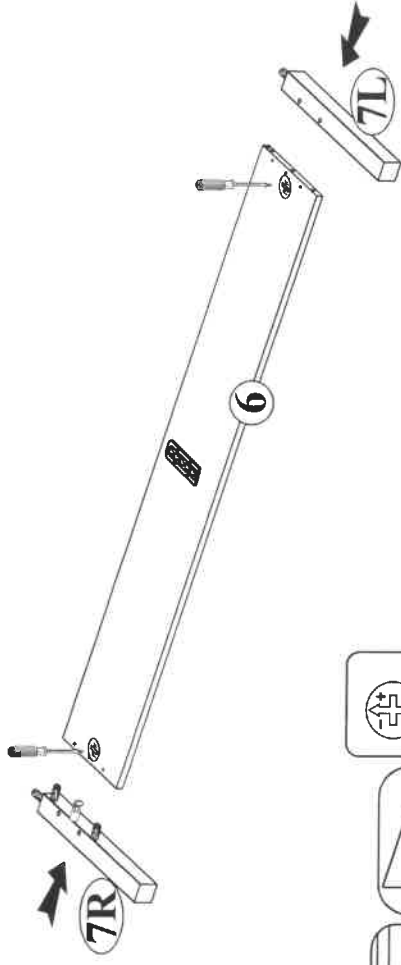

8

- L1
-  x2

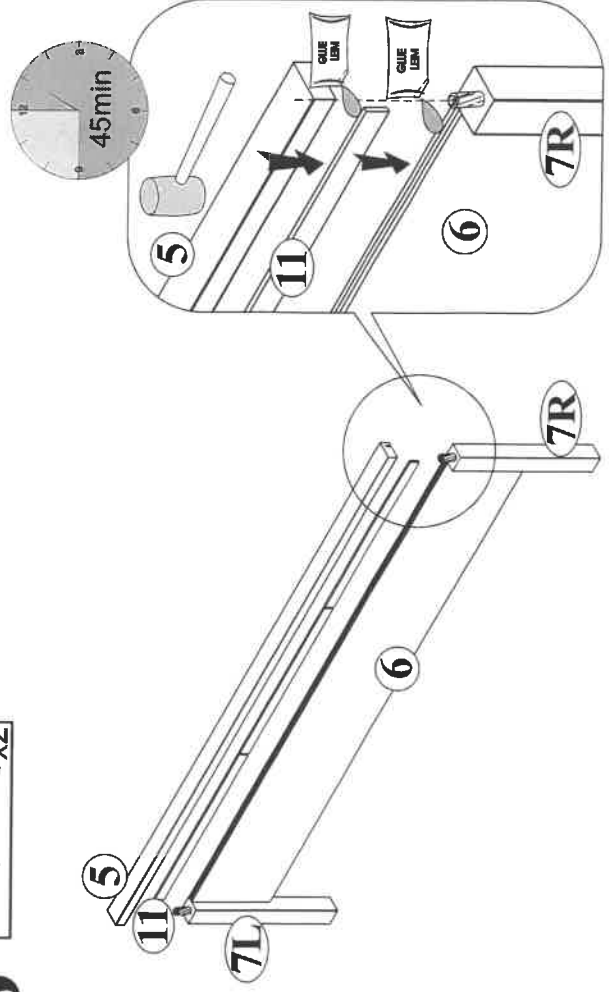

9

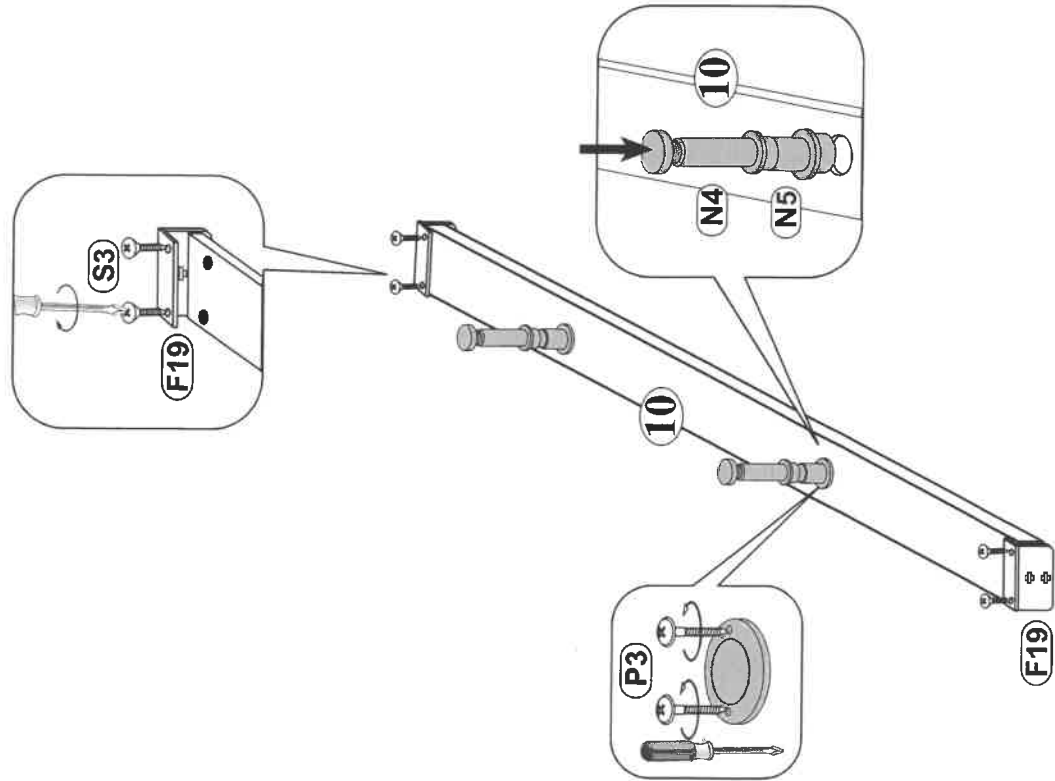
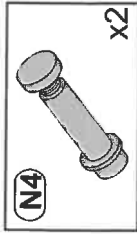

10

